

Typ 3 677 04 15 0

Škoda Octavia III. Limousine 02/13 →
Škoda Octavia III. Combi 05/13 →



ca ...30 min.

Milotec®

Diffusor • Difuzor • Diffuser • Diffuseur d'air

Montageanleitung
Montážní návod
Fitting instructions
Instructions de montage

ATEST
8 SD
1951

Návod uschovejte
pro účely kontroly a STK!

Technische Änderungen vorbehalten
Technická změna vyhrazena
Subject to technical alterations
Sous réserves de modifications techniques

Lieferumfang • Obsah balení • The pack contains • Fournitures:

Ⓐ

1 x

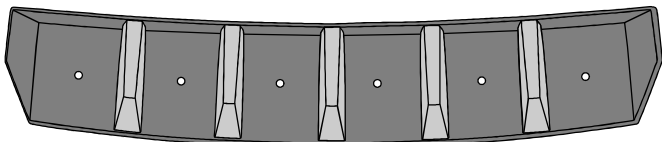

Ⓑ 6 x

4,1 x 9



Ⓒ 1 x

Montageanleitung
Montážní návod
Fitting instructions
Instructions de montage

Ⓓ 1 x

Lackierhinweis
návod pro lakování
painting instructions
instructions de vernissage

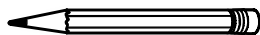

TORX 20



∅ 2,5 mm

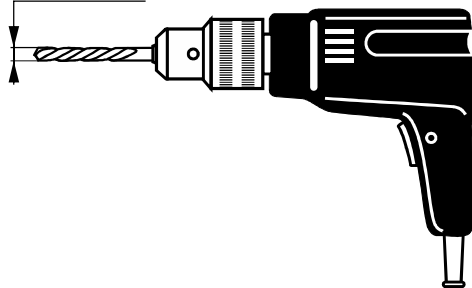

1.

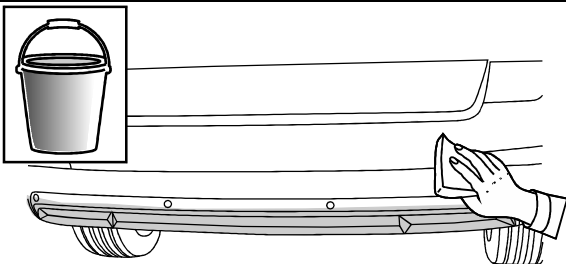

2.

TEST

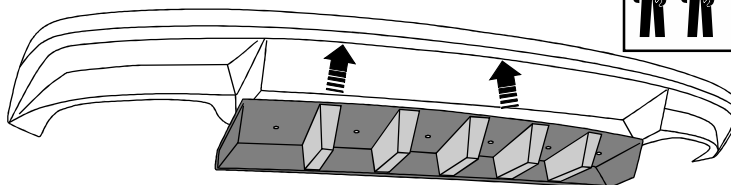

3.

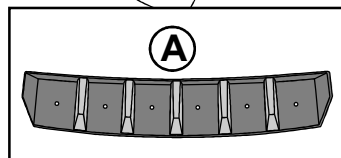

Ⓐ

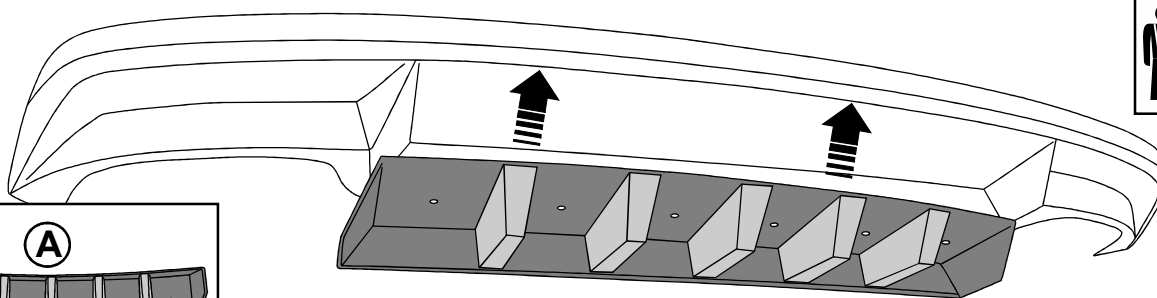

4.

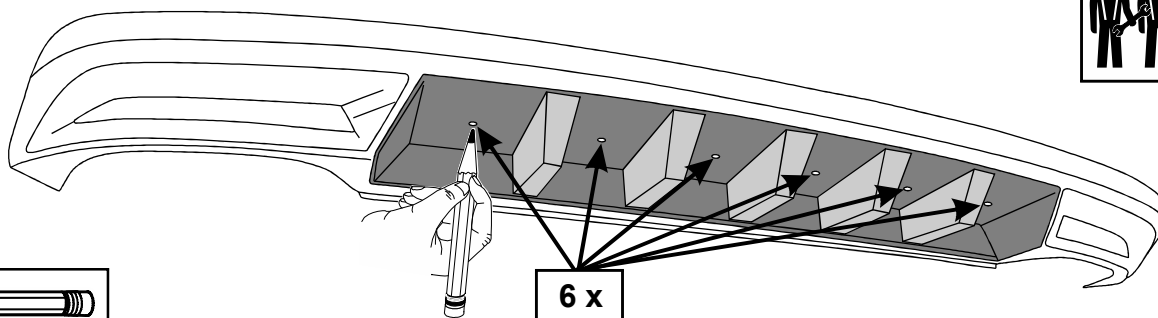

6 x



5.

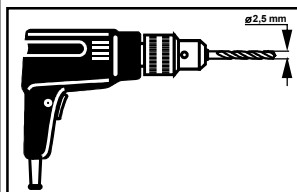
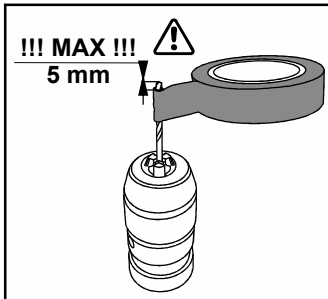
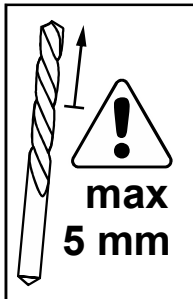
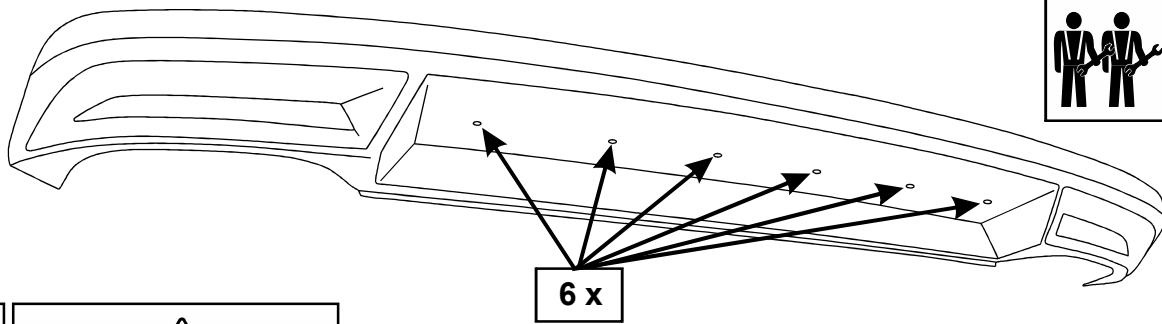

6.

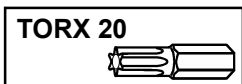
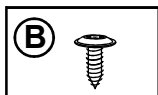
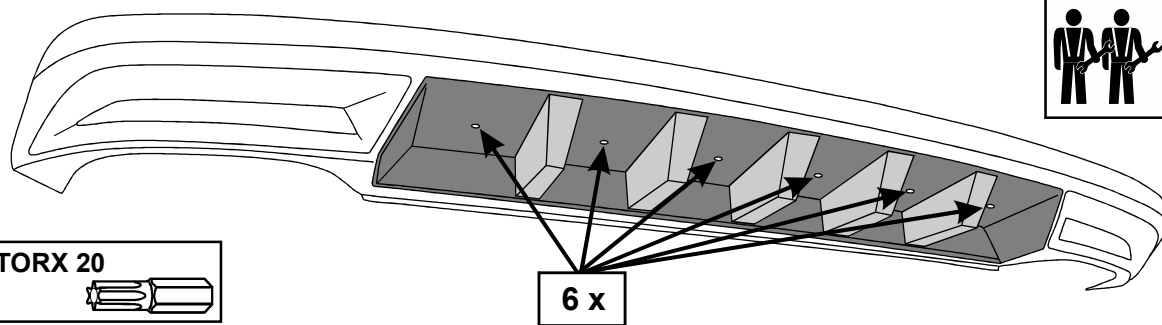

7.

