

# Typ 4 502 01

Škoda Fabia IV. 2021 →

Fußstütze • Sportovní opěrka nohy • Foot rest • Repose-pied

Montageanleitung • Montážní návod  
Fitting instructions • Instructions de montage



# Milotec

ca ...10 min.

Technische Änderungen vorbehalten  
Technická změna vyhrazena  
Subject to technical alterations  
Sous réserves de modifications techniques

Lieferumfang • Obsah balení  
The pack contains • Fournitures

Ⓐ 1 x

Ⓑ 4 x

4,5 x 24 mm



Ⓒ 1 x

Montageanleitung  
Montážní návod  
Fitting instructions  
Instructions de montage

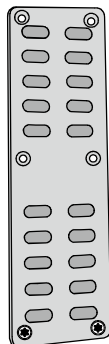

Werkzeug • Nářadí • Tools • Outils

∅ 2,5 mm

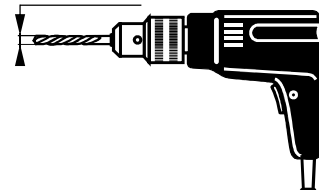

Torx 25

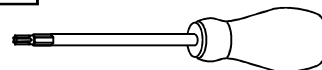
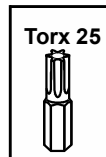

1.

CENTER

10 mm

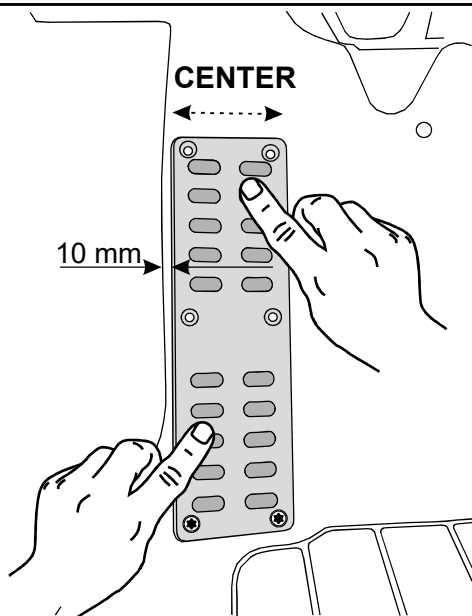

2.

10 mm

4 x

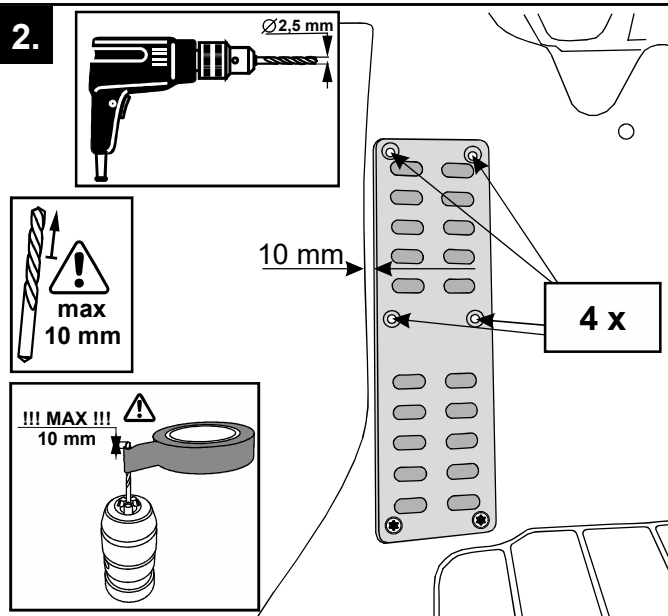

3.

Ⓑ 4 x

4,5 x 24 mm

Torx 25

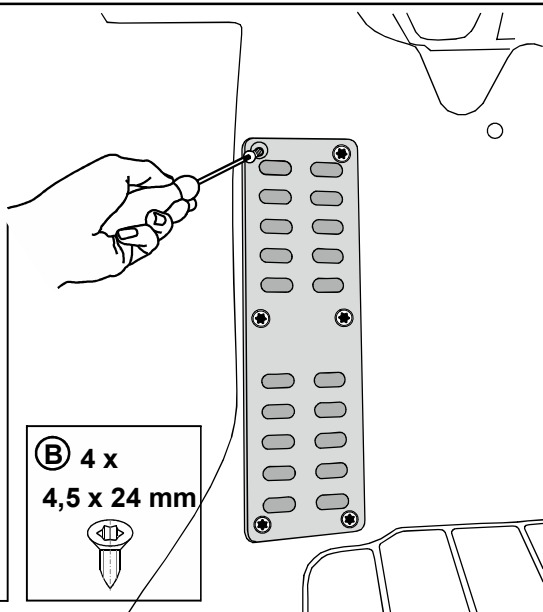

4.

